



## 80cm satellite dish









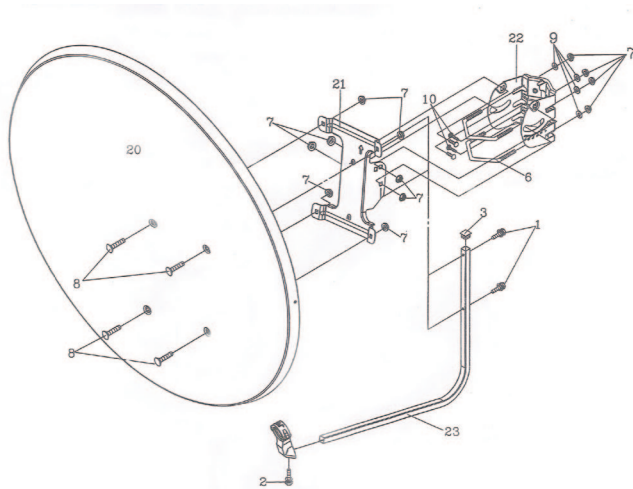







Ideal for high definition satellite reception.  
Outdoor installation

- 1 year warranty
- Easy to assemble

## TECHNICAL INFORMATION

Specifications:	
Item & Spec.	DE80
Offset Angle	24.62
Effective Physical Size (cm)	W80xH86
Focus Length (mm)	480
S-band Gain @ 2.5GHZ	25.97dB
C-band Gain @ 4.0GHZ	-
Ku-band Gain @ 12.5GHZ	38.96dB
Elevation	10°~80°/0°~90°
Azimuth	0°~360°
Aperture Efficiency	75% (min)
F/D Ratio	0.6
Weight	8.5kg
Material	Mild Steel
Finishing	Polyester Powder
Color	Gray/Cool Gray
Standard Mount	G/W
Pole diameter Acceptable (mm)	38~50
Ambient Temperature	-40°~+60°C
Relative Humidity	0~100%



No.	Item	Description
25		40mm LNB Clamp
24		40mm LNB Clamp Holder
23		LNB Arm
22		F - Mast Bracket
21		Reflector Bracket
20		80cm Satellite Reflector Dish
10		M6*15 Round Head Screw
9		M6 Washer
8		M6*15 Round Flat Head Square Screw
7		M6 Flange Nut
6		M6*W53 U Square Bolt
5		M4 Hex Nut
4		M4*16 Round Head Cross Screw
3		Cover
2		M6*12 Hex Head Cap Screw w/sw/w
1		M6*30 Hex Head Cap Screw w/w

## THE PACKAGE CONTAINS

- 1 x (80cm x 89cm) Satellite Dish

## PACKAGE DIMENSIONS

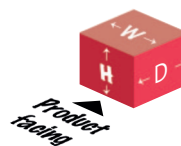

Height (mm)	Depth (mm)	Width (mm)	Weight (kg)
860	84	800	5.0